

# Vereinswertung

19. Nickelhütte Turnier 28.01.2017

	Verein	Teiln.	1. Platz	2. Platz	3. Platz	Kampfl.	Gesamt
1.	Landeskader BTV	37	19	8	7		145
2.	Zwönitzer HSV 1928 e.V. - Abteilung Taekwondo	13	3	5	4		37
3.	Taifun Leipzig e.V.	9	4	3	1		34
4.	Kampfsportzentrum Universum Meiningen e.V.	10	3	4	1		31
5.	Taekwondo Verein Limbach-Oberfrohna e.V.	8	2	3	3		24
6.	SG Nickelhütte Aue e.V. - Sektion Taekwondo	12	1	3	7		22
7.	Taejang Dojang Teplice	7	2	2	3		21
8.	Taekwondo Gemeinschaft Schönebeck Wild Devils e.V.	6	1	4	1		19
9.	TaekwonDo - Dojang Bautzen e.V.	7	2	1	4		19
10.	Athletik Sport-Verein Erfurt e.V. / Abteilung Taekwondo	5	1	4			18
11.	SV Sachsenring Hohnstein-Ernstthal e.V. - Abteilung Taekwondo	3	2	1			15
12.	Taekwondo Gemeinschaft Leipzig-Paunsdorf e.V.	3	2		1		13
13.	TASG Dresden e.V.	3	2				12
14.	TuS Osterburg '90 Weida e.V., Abt. TKD	3	1	2			12
15.	Taekwondo Gemeinschaft Eilenburg e.V.	5		3	2		11
16.	Kampfkunst- Center Black Dragon e.V. Abteilung Taekwondo	6	1	1	2		11
17.	Taekwondo Verein Falkenstein e.V.	9		2	5		11
18.	Satori e.V.	4	1	1	1		10
19.	Han Kook Bad Schlema e.V.	4	1		3		9
20.	Mitteldeutscher TKD Verein "Fight 4 Fun" e.V.	4	1		2		8
21.	TKD Club Donau - Lech - Iller e.V.	2	1		1		7
22.	PSV Magdeburg / Kobras	1	1				6
23.	1. Taekwondo Club Chemnitz e.V.	3		1	2		5
24.	Taekwondo Verein Tangun Brandis e.V.	2		1	1		4

# Vereinswertung

19. Nickelhütte Turnier 28.01.2017

	Verein	Teiln.	1. Platz	2. Platz	3. Platz	Kampfl.	Gesamt
25.	Taekwondo Club Aken e.V.	1		1			3
25.	SG MoGoNo Leipzig e.V. - Abteilung Taekwondo & Allkampf	1		1			3
26.	SV Bad Düben e.V. - Abteilung Taekwondo	1			1		1

# Einzelergebnisse

19. Nickelhütte Turnier 28.01.2017

Klasse	1. Platz	2. Platz	3. Plätze	
H -58 LK 2	Valy, Sohrab Landeskader BTV	Gol Wali, Saeedi Landeskader BTV		
H -63 LK 2	Dong, Viet Duc Satori Dresden	Dietrich, Maximilian Chemnitz	Borisch, Jörg Falkenstein	
H -68 LK 1	Scheppan, Kevin Bad Schlema	Harter, Allyson Leipzig MoGoNo	Stargardt, Patrick Landeskader BTV	
H -74 LK 1	Hocke, Kevin Meiningen	Kraft, Michael ASV Erfurt	Sammar, Abdulrhaman Landeskader BTV	Modes, Eike Chemnitz
H -74 LK 2	Müller, Tommy Bautzen	Nötzold, Joachim Hohenstein-Ernstthal		
H -80 LK 2	Illig, Bastian Hohenstein-Ernstthal	Tappert, Toni ASV Erfurt	Müller, Carsten Bautzen	Thiele, Uwe Leipzig Tangun Brandis
H -87 LK 1	Krasilnikovs, Nikita Leipzig Taifun	Calakei, Nico Bautzen	Krüger, Sebastian Landeskader BTV	Ahmed Kelif Abdo, Asledin Leipzig Paunsdorf
H 87+ LK 2	Grabe, Sebastian ASV Erfurt	Stereov, Slatan Meiningen		
D -53 LK 1	Opelt, Jessica Hildburghausen	Mahler, Julia Leipzig Taifun		
D -62 LK 1	Basar, Dilara Landeskader BTV	Bauer, Caroline Aken		
D -73 LK 1	Bierstedt, Lucie Magdeburg Kobras	Demirkol , Mihriban Landeskader BTV		
JAm -48 LK 1	Beganovic, Samuel Landeskader BTV	Merkel, Dominik Zwönitz	Scheppan, Justin Bad Schlema	
JAm -48 LK 2	Nazari, Halil Landeskader BTV	Karge, Eric Satori Dresden		
JAm -55 LK 1	Beganovic, Manuel Landeskader BTV	Richter, Rico Weida	Calov, Joe Limbach Oberfrohna	Butscheck, Pascal Schönebeck Wild Devils
JAm -55 LK 2	Biedermann, Tom Bautzen	Xu, Andy Landeskader BTV	Manke, Robin Fight 4 Fun	Klatt, Erik Eilenburg

# Einzelergebnisse

19. Nickelhütte Turnier 28.01.2017

Klasse	1. Platz	2. Platz	3. Plätze	
JAm -59 LK 1	Jeglinski, Martin Schönebeck Wild Devils	Kader, Justin Schönebeck Wild Devils	Schenk, Pascal Hildburghausen	Brähne, Max Fight 4 Fun
JAm -59 LK 2	Gogilaschwili, Nikita Landeskader BTV	Förster, Paul Landeskader BTV	Schenk, Edwin Bautzen	Ahmadi, Aboser Leipzig Taifun
JAm -63 LK 1	Eccarius, Forian Landeskader BTV	Genthe, Jan Schönebeck Wild Devils	Kaminsky, Hannes Eilenburg	Franke, Tom Aue
JAm -68 LK 2	Schuster, Jonas Fight 4 Fun	Block, Maximilian Schönebeck Wild Devils	Schütz, Erik Aue	
JAm -73 LK 1	Ebert, Sören Aue	Hocke, Max Meiningen		
JAw -42 LK 2	Klinger, Clara Zwönitz	Zander, Laura Meiningen		
JAw -55 LK 1	Walther, Theresa Leipzig Taifun	Häusler, Vivian ASV Erfurt	Jahaf, Albatool Taejang Dojang Teplice	
JAw -59 LK 1	Trampel, Franka Weida	Schmidt, Anja Doreen Zwönitz	Röhling, Antonia Zwönitz	
JBm -33 LK 1	Shabanbaev, Artem Landeskader BTV	Özütok, Ali Fuat Landeskader BTV	Kretzschmar, Jonas Limbach Oberfrohna	
JBm -33 LK 2	Haas, Robin Zwönitz	Pelka, Kevin Philipp Leipzig Taifun	Bayerbakh, Roman Bad Dübén	Strehler, Silvio Bautzen
JBm -37 LK 1	Wagner, Aurelius TASG Dresden	Kilbel, Konstantin Limbach Oberfrohna	Sajaz, Alexander Donau-Lech-Iller	
JBm -37 LK 2	Junge, Felix Leipzig Taifun	Ilze, Deniz Emre Hildburghausen	Dyck, Simon Aue	Thiemann, Nick Aue
JBm -41 LK 1	Klemm, Maximilian TASG Dresden	Kuchar, Niels Meiningen		
JBm -45 LK 1	Mohammad, Ahmed Landeskader BTV	Tabler, Heinrich-Lucas Landeskader BTV	Barz, Alexander Meiningen	Deisinger, Anton Limbach Oberfrohna
JBm -45 LK 2	Haseinovic, Erdal Landeskader BTV	Hempel, Andreas Eilenburg	Suchomel, Anthony Falkenstein	Schneider, Emil Bautzen
JBm -49 LK 2	Hamzehian, Arian Leipzig Paunsdorf	Broz, Krystof Taejang Dojang Teplice	Erler, Karl Louis Satori Dresden	Uhlig, Pascal Bad Schlema

# Einzelergebnisse

19. Nickelhütte Turnier 28.01.2017

Klasse	1. Platz	2. Platz	3. Plätze	
JBm -57 LK 2	Erol, Kaan Landeskader BTV	Süß, Georg Zwönitz		
JBw -33 LK 1	Özütok, Sude Bahar Landeskader BTV	Deisinger, Henriette Limbach Oberfrohna	Pfaff, Marbele Zwönitz	
JBw -37 LK 1	Hauser, Luisa Zwönitz	Buchholz, Emily Weida		
JBw -37 LK 2	Ahmadi, Ilham Leipzig Taifun	Fritze, Renée-Josefin Schönebeck Wild Devils	Meinel, Jasmin Falkenstein	
JBw -41 LK 2	Rehbach, Sophia Limbach Oberfrohna	Claus, Annabell Falkenstein	Kunze, Alexandra Aue	
JBw -44 LK 1	Sahin, Melinda Landeskader BTV	Flegrova, Hana Taejang Dojang Teplice	Lerch, Celine Zwönitz	
JBw -47 LK 2	Abt, Finja Meiningen	Salzer, Nele Aue	Windisch, Maya Aue	
JBw -51 LK 1	Limani, Arijeta Landeskader BTV	Reichelt, Chiara Sophie Limbach Oberfrohna		
JBw -55 LK 2	Jahafova, Nwar Taejang Dojang Teplice	Müller, Felizitas ASV Erfurt	Hasanova, Miriam Taejang Dojang Teplice	
JCm -27 LK 2	Limani, Yasin Landeskader BTV	Beganovic, Izet Landeskader BTV	Schulz, Johannes Hildburghausen	Weani, Deni Chemnitz
JCm -29 LK 2	Weis, David Landeskader BTV	Ahmadi, Abulfasl Leipzig Taifun	Richter, Lenny-Rene Zwönitz	Westphal, Florian Bad Schlema
JCm -32 LK 2	Paruzek, Krystof Taejang Dojang Teplice	Elter, Alessandro Aue	Wirth, Lucas Falkenstein	
JCm -35 LK 2	Noack, Jason Leipzig Paunsdorf	Radke, Jonas Zwönitz	Petzoldt, Maximilian Aue	Eckardt, Friedrich Landeskader BTV
JCm -39 LK 2	Iraqi, Ahmed Landeskader BTV	Fücker, Iven Falkenstein	Tischer, Theodor Falkenstein	
JCm -43 LK 2	Beganovic, Sejfudin Landeskader BTV	Dähmlow, Julien Eilenburg		
JCm -47 LK 2	Friedrich, Ian Hohenstein-Ernstthal	Schickling, Phil Aue		

# Einzelergebnisse

19. Nickelhütte Turnier 28.01.2017

Klasse	1. Platz	2. Platz	3. Plätze	
JCw -27 LK 2	Limani, Elmedina Landeskader BTV	Erol, Havin Zeliha Landeskader BTV		
JCw -29 LK 2	Grimm, Isabel Meiningen	Richter , Jule Zwönitz	Flegrova, Amalie Taejang Dojang Teplice	
JCw -39 LK 2	Welker, Lara Limbach Oberfrohna	Zoch, Linda Leipzig Tangun Brandis	Tabler, Emily Landeskader BTV	Salai, Tijana Landeskader BTV
JDm -24 LK 2	Bakscheyew, Martin Donau-Lech-Iller	Lindner, Jamie Eilenburg	Özütok, Berkaycan Landeskader BTV	

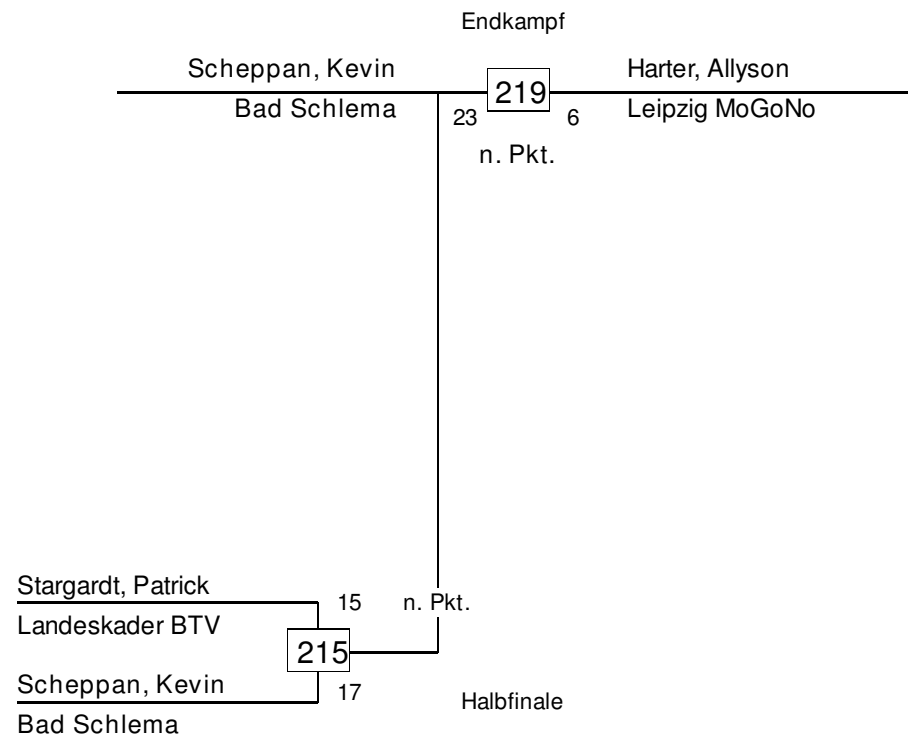

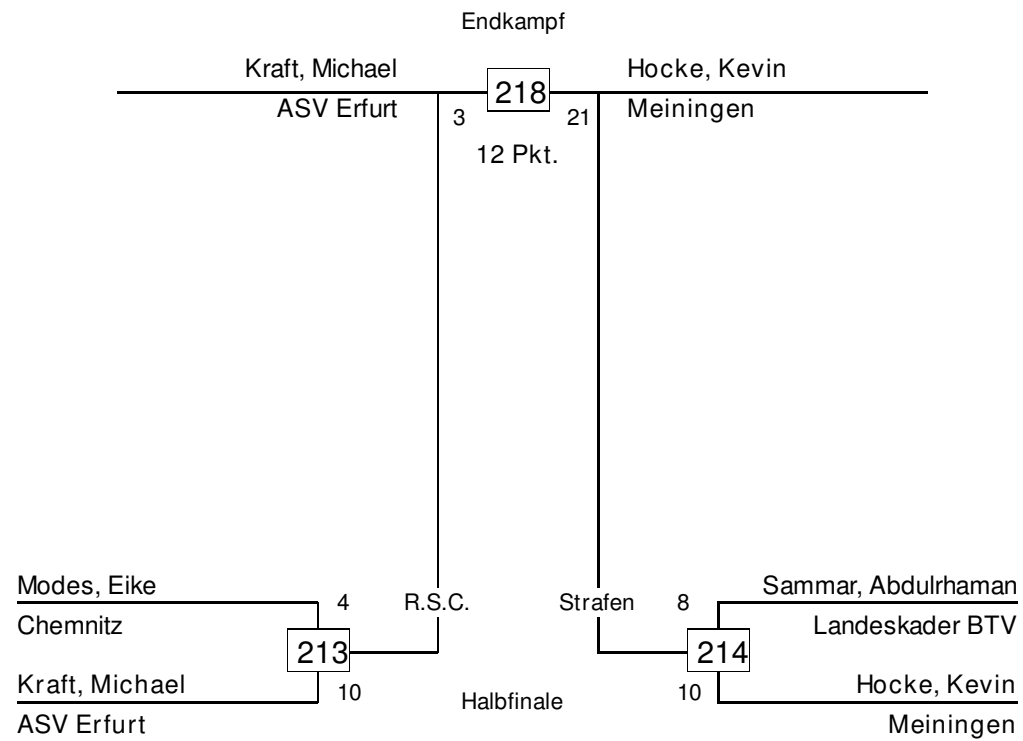



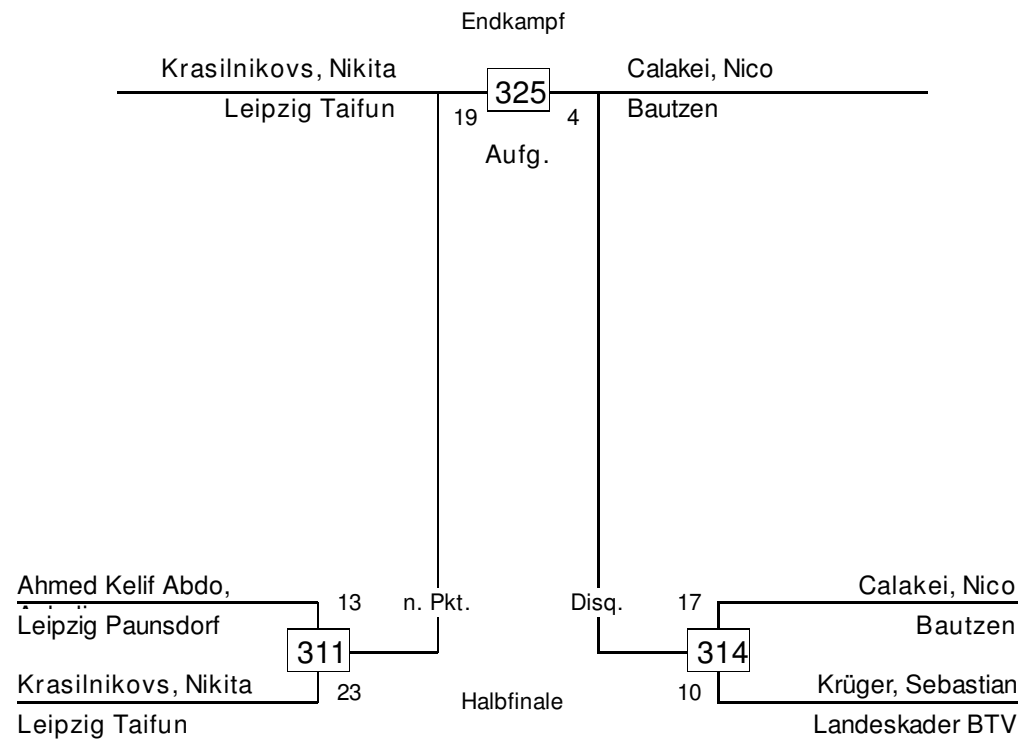

Endkampf

Mahler, Julia  
Leipzig Taifun

8

227

16

Opelt, Jessica  
Hildburghausen

n. Pkt.

		Endkampf		
Bauer, Caroline				Basar, Dilara
Aken	12	225	32	Landeskader BTV
		12 Pkt.		

Endkampf

Bierstedt, Lucie		Demirkol , Mihriban
Magdeburg Kobras	13 <span style="border: 1px solid black; padding: 2px;">223</span> 8	Landeskader BTV
	n. Pkt.	

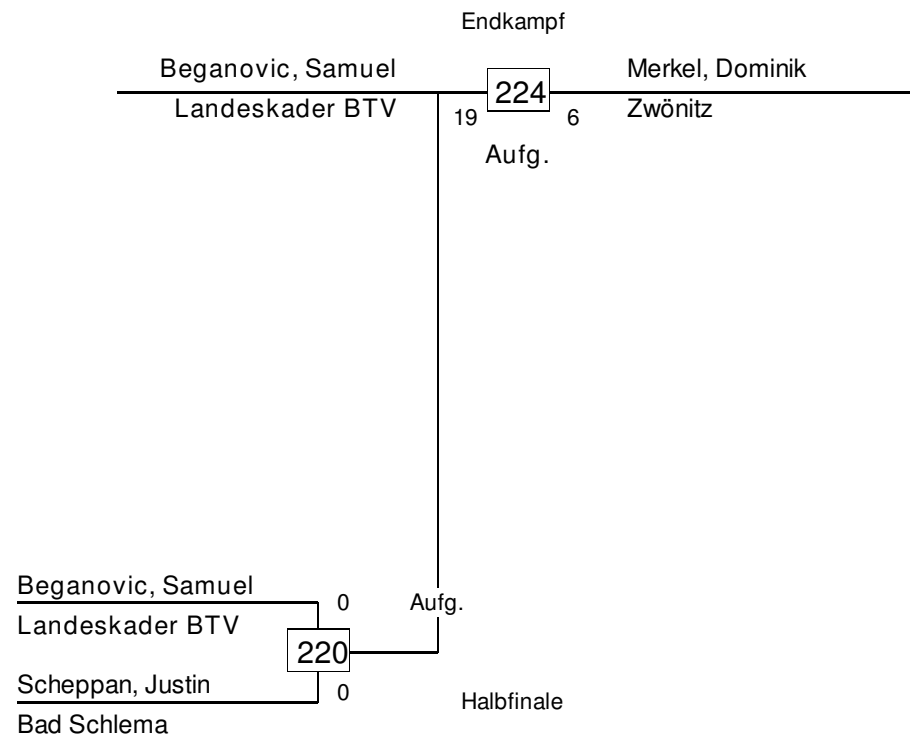

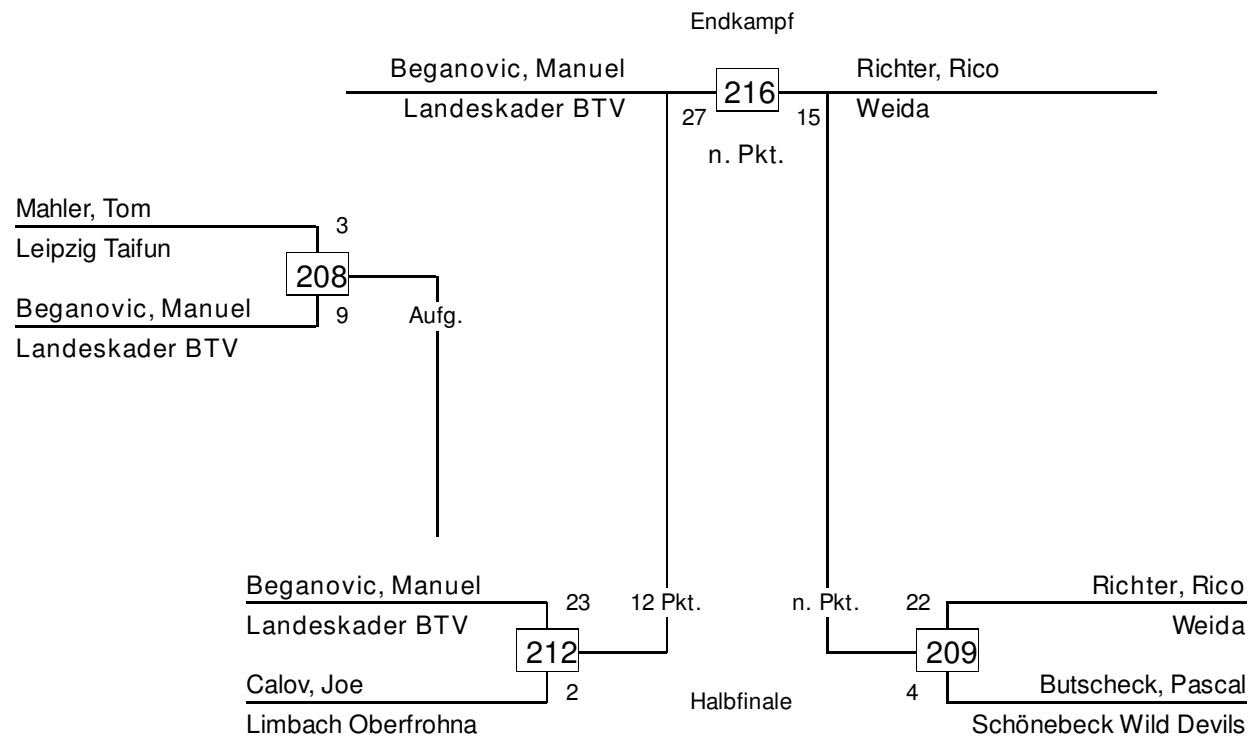

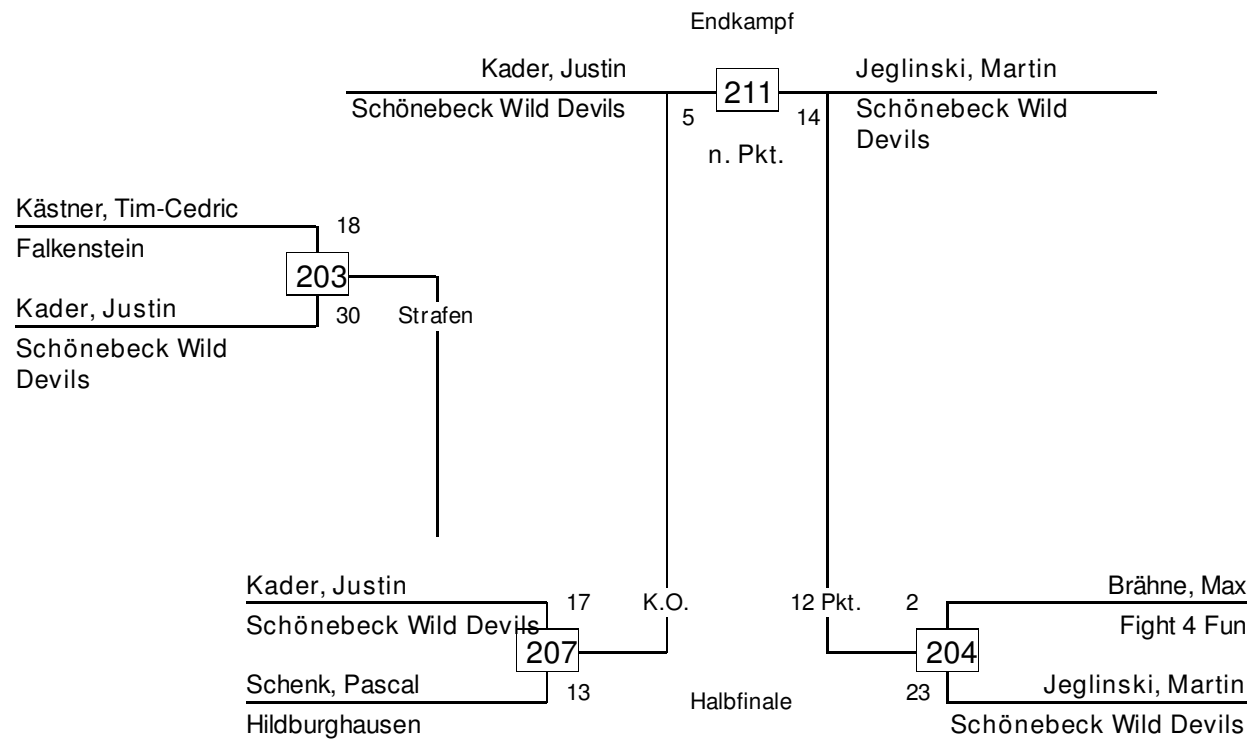

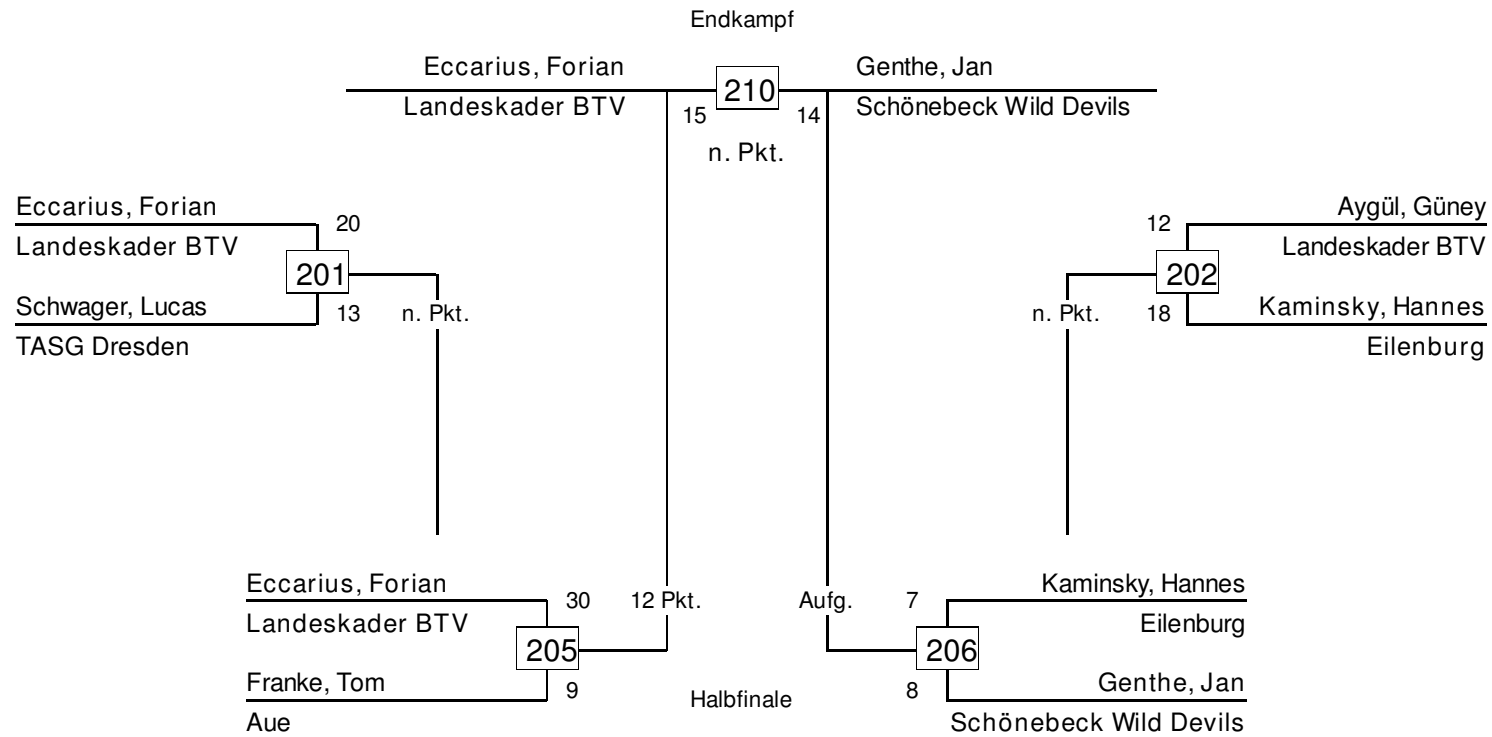



		Endkampf			
Ebert, Sören				Hocke, Max	
Aue	15	324	11	Meiningen	
		n. Pkt.			

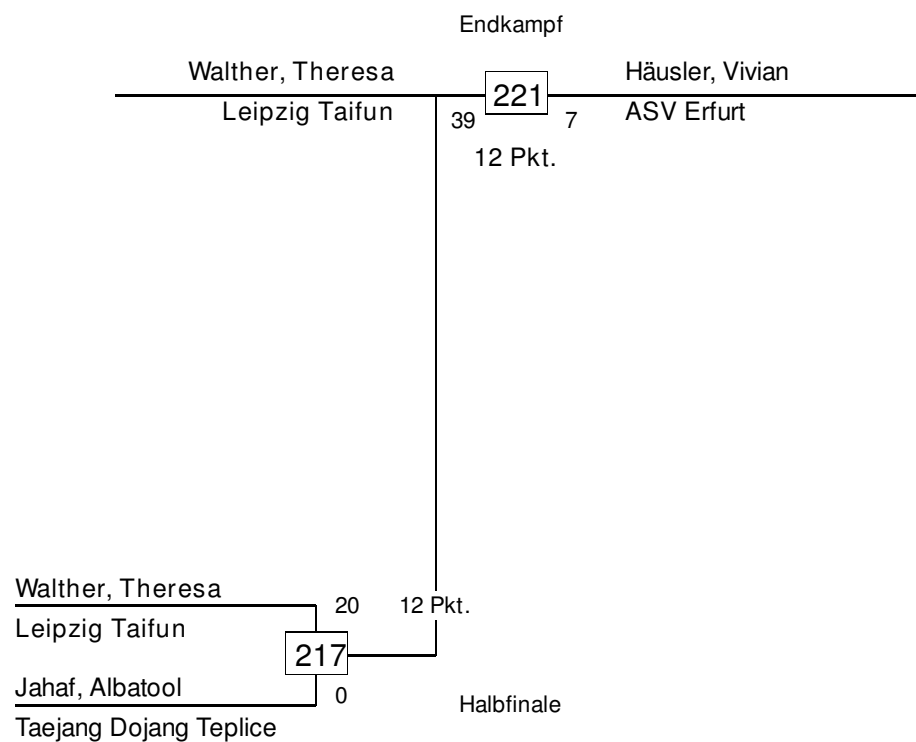

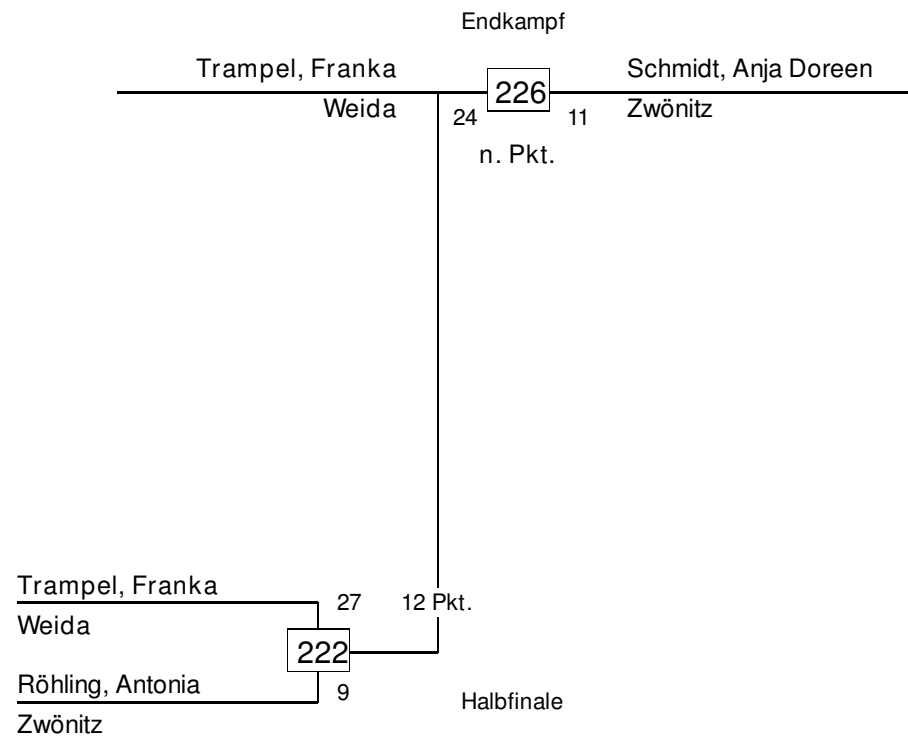

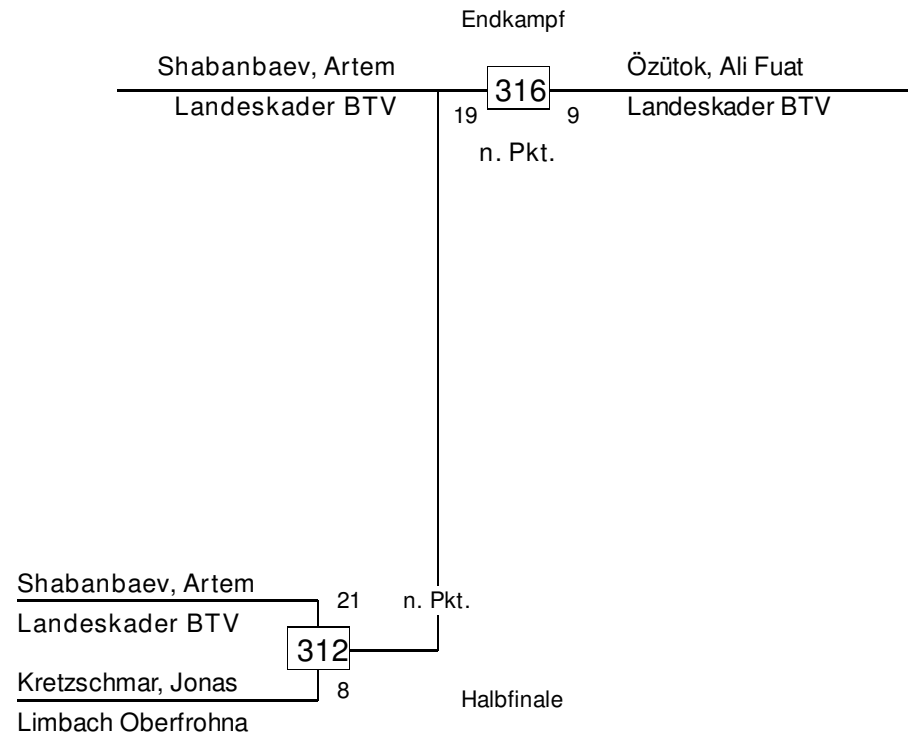

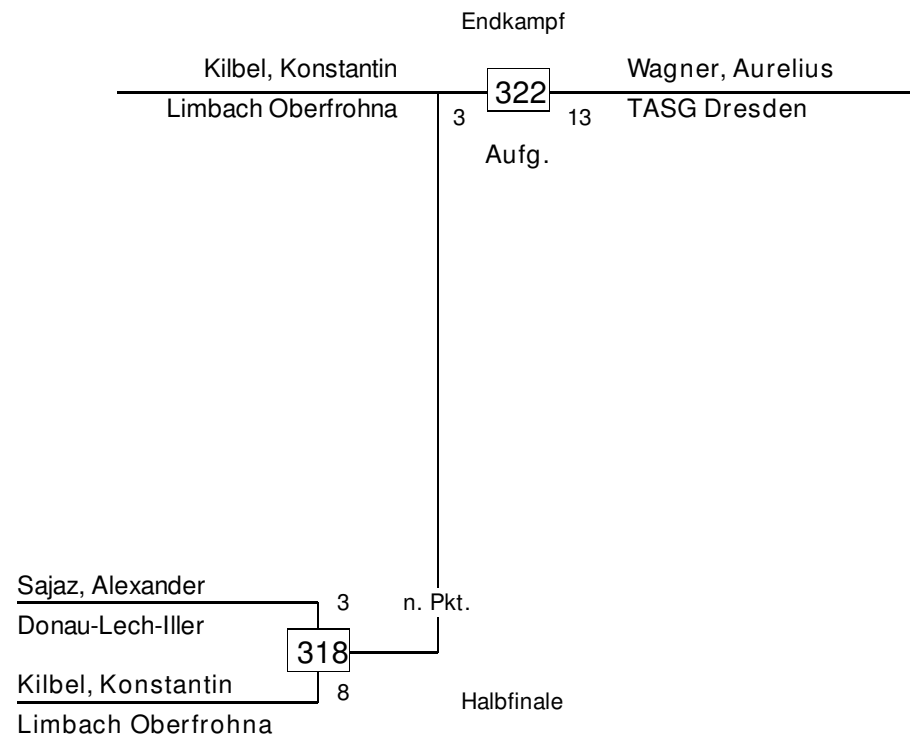

Endkampf

Klemm, Maximilian

Kuchar, Niels

TASG Dresden

Meiningen

9

321

8

n. Pkt.

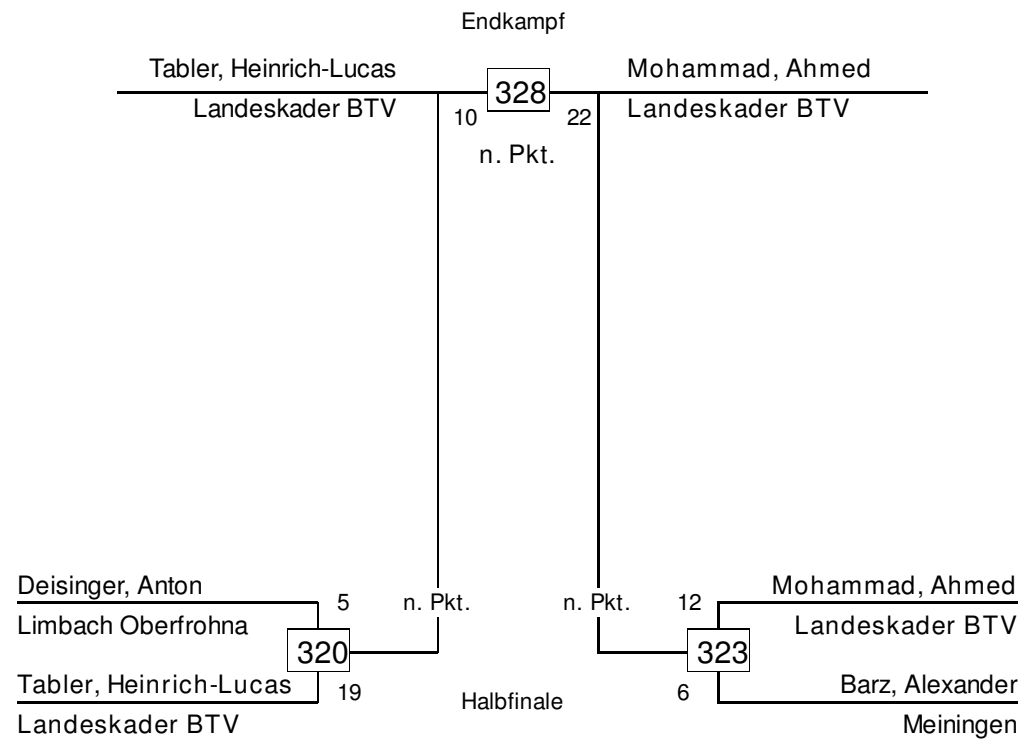

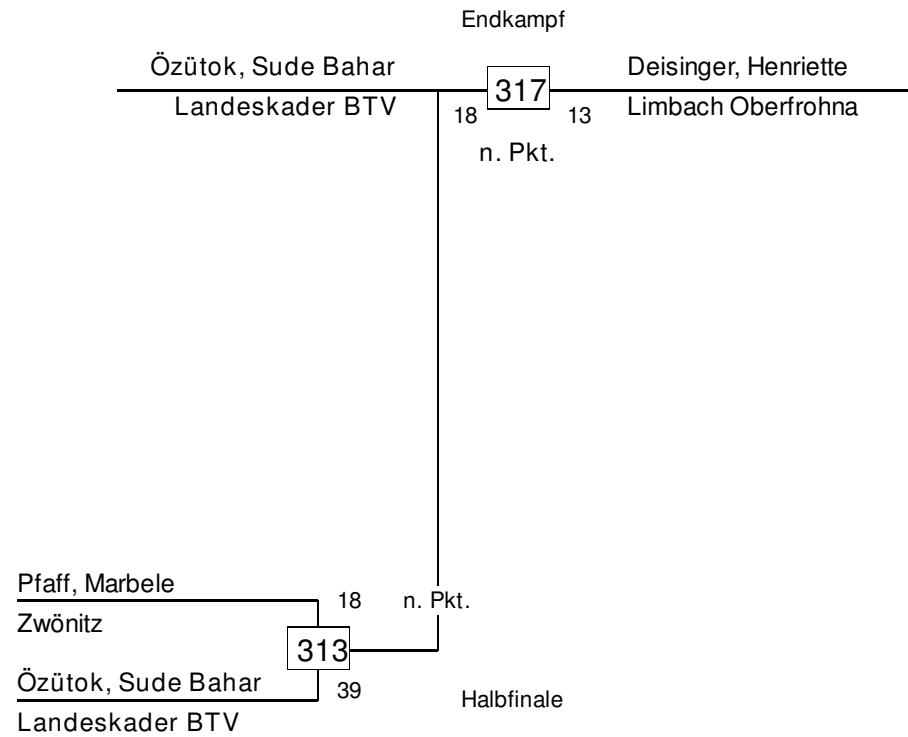



		Endkampf		
Hauser, Luisa		326		Buchholz, Emily
Zwönitz	22		4	Weida
		n. Pkt.		

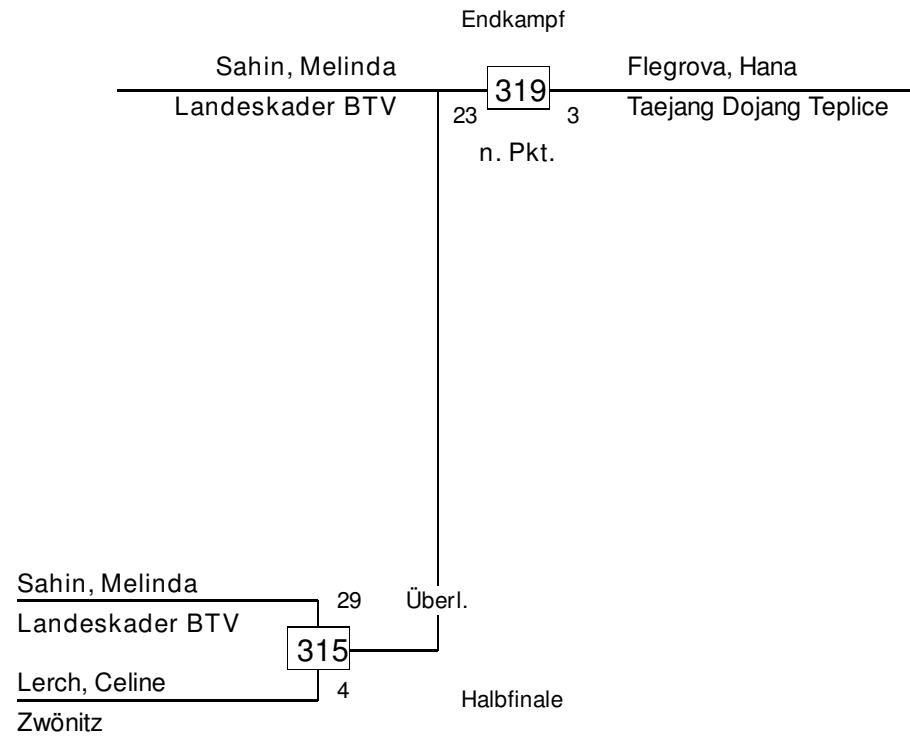

Endkampf

Limani, Arijeta				Reichelt, Chiara Sophie
Landeskader BTV	13	327	6	Limbach Oberfrohna
		Aufg.		

		Endkampf		
Gol Wali, Saeedi				Valy, Sohrab
Landeskader BTV	14	305	25	Landeskader BTV
		n. Pkt.		

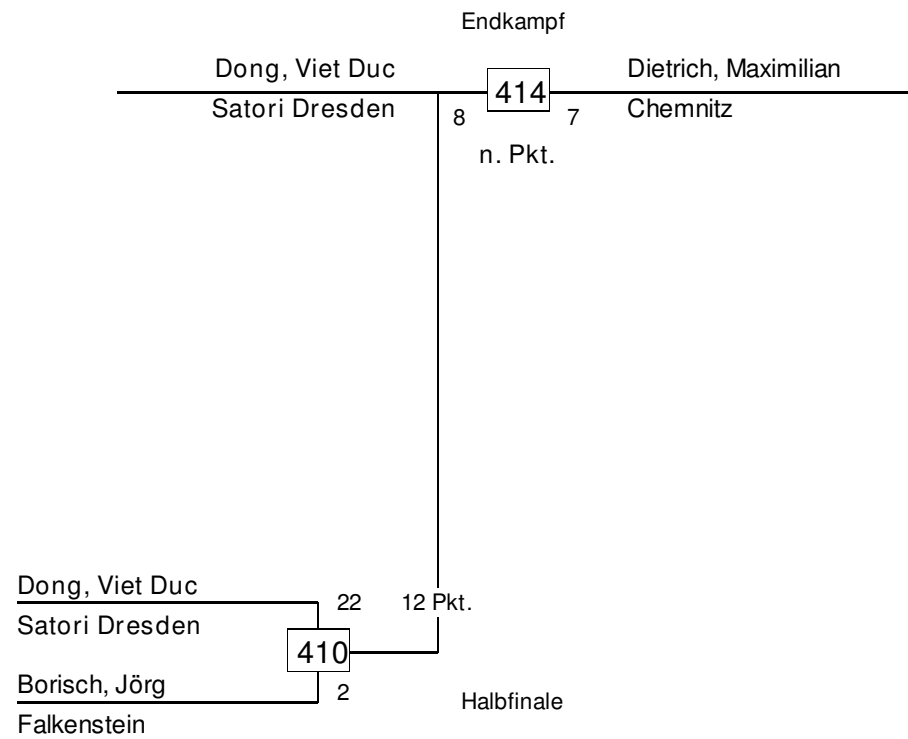

	Endkampf		
Müller, Tommy		Nötzold, Joachim	
Bautzen	16	<b>310</b>	3
			Hohenstein-Ernstthal
		n. Pkt.	

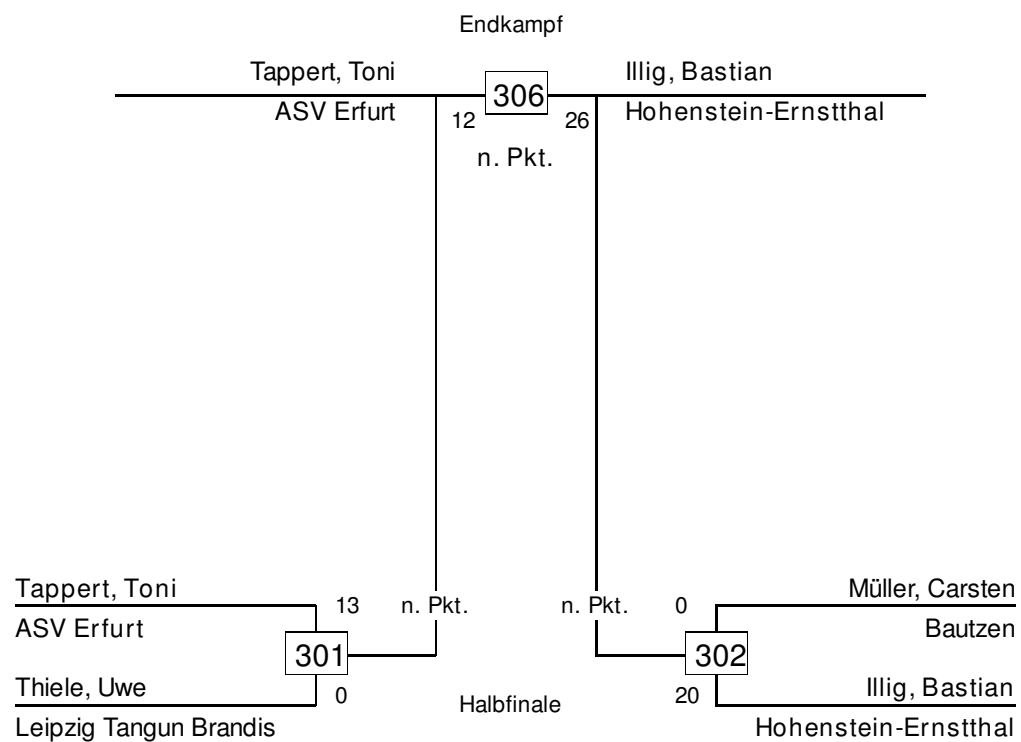

Endkampf

Stereov, Slatan				Grabe, Sebastian
Meiningen	6	<b>309</b>	12	ASV Erfurt
		K.O.		



Endkampf

Nazari, Halil		Karge, Eric
Landeskader BTV	19 <span style="border: 1px solid black; padding: 2px;">308</span> 5	Satori Dresden
	K.O.	

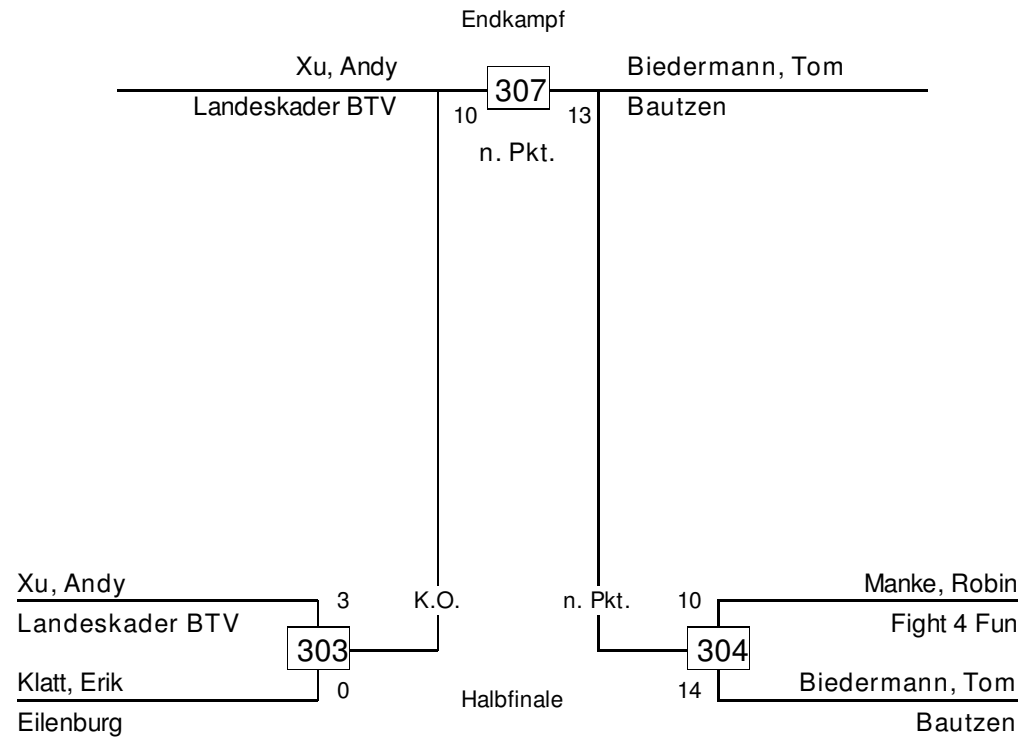

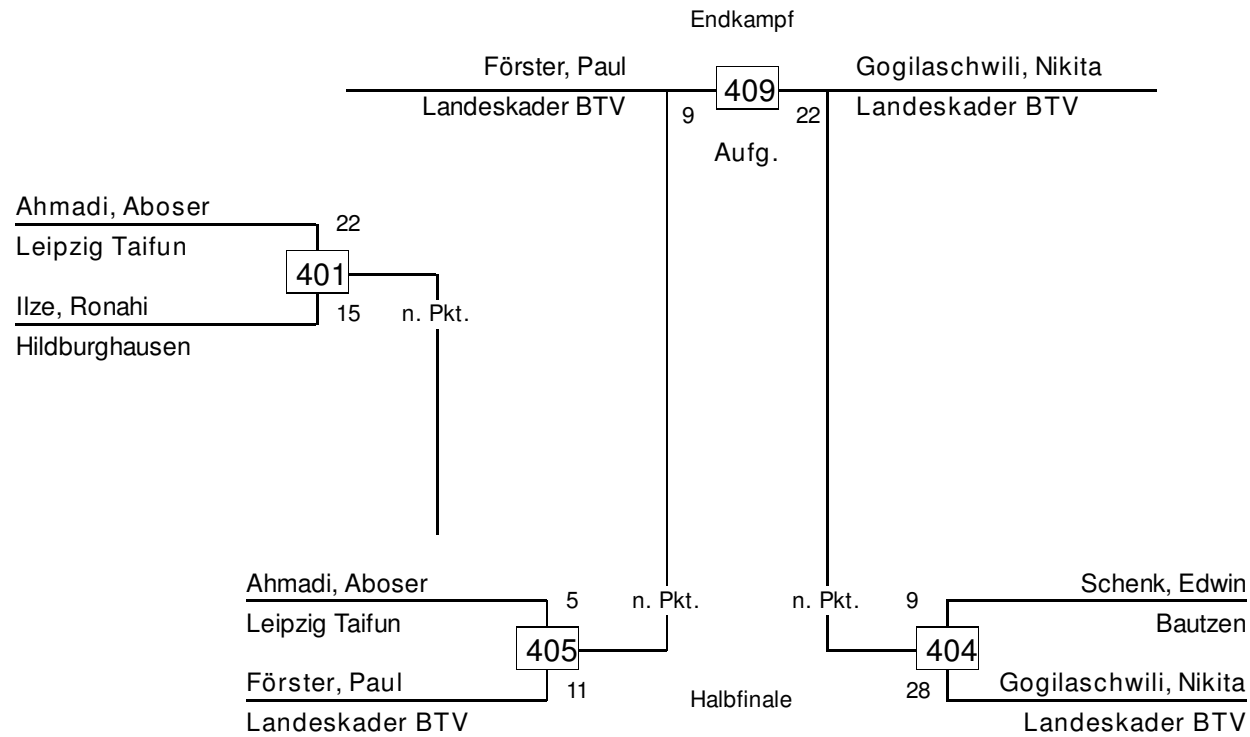

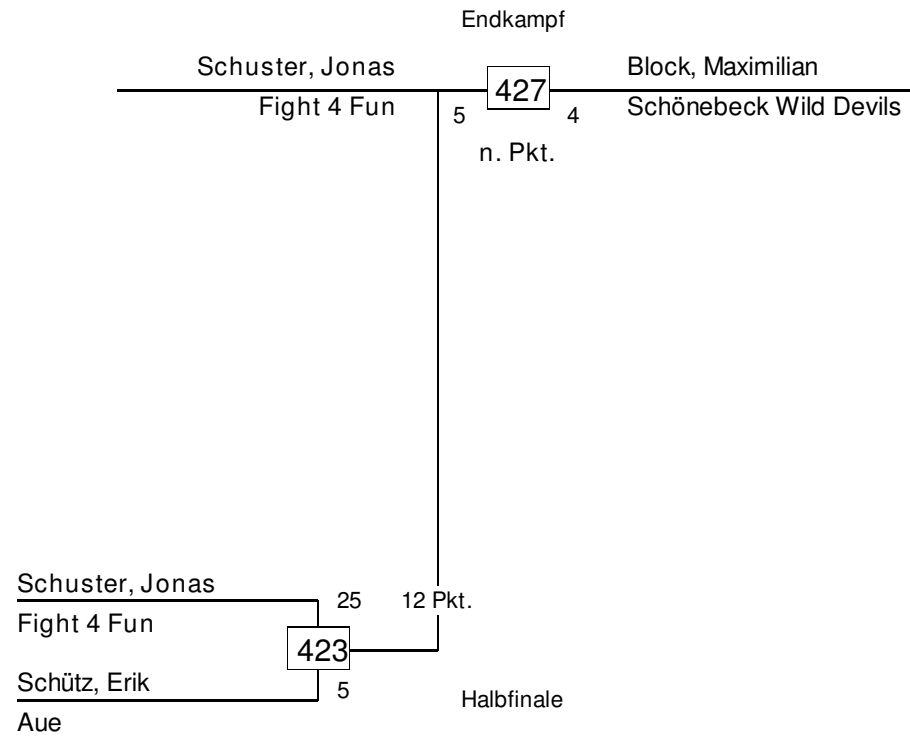

Endkampf

Klinger, Clara		Zander, Laura
Zwönitz	10 <span style="border: 1px solid black; padding: 2px;">430</span> 0	Meiningen

Aufg.

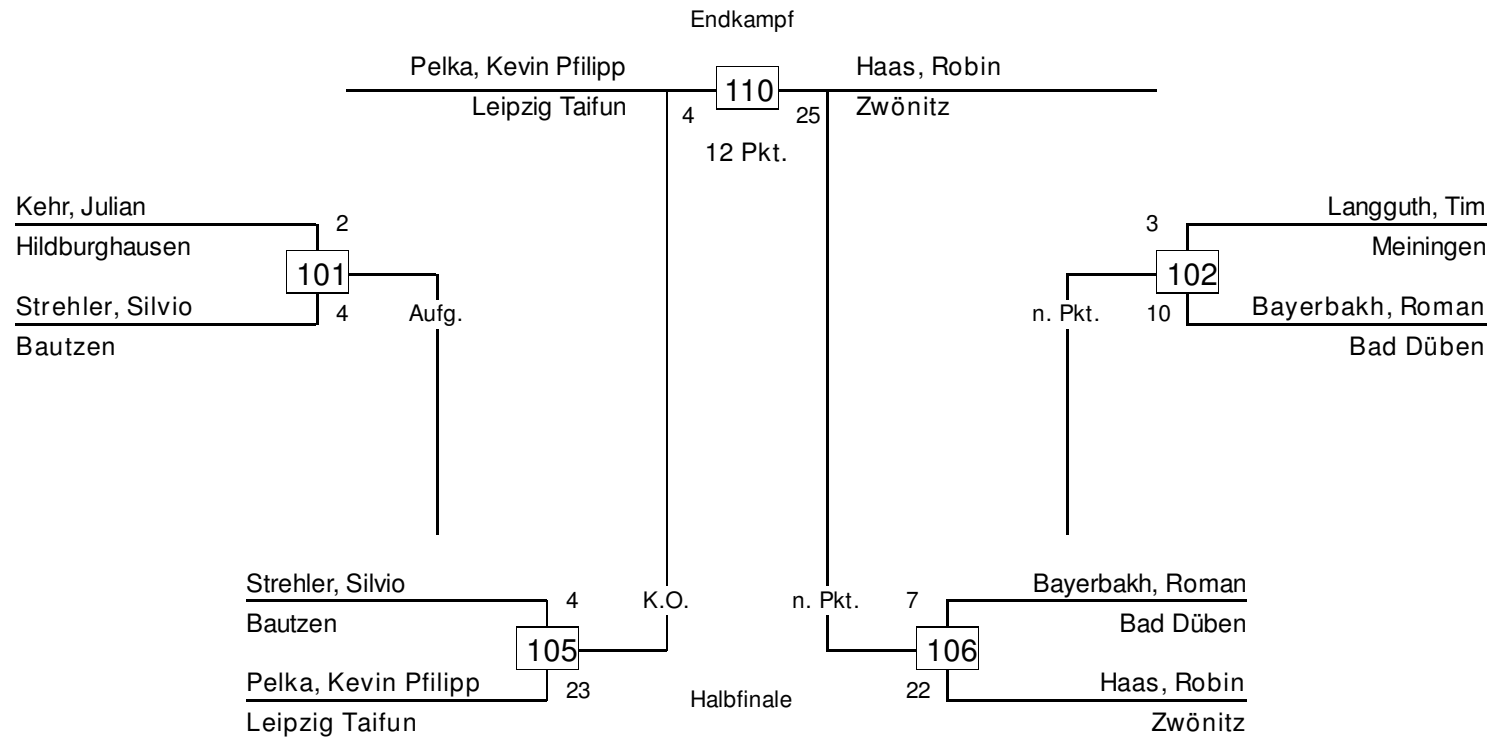

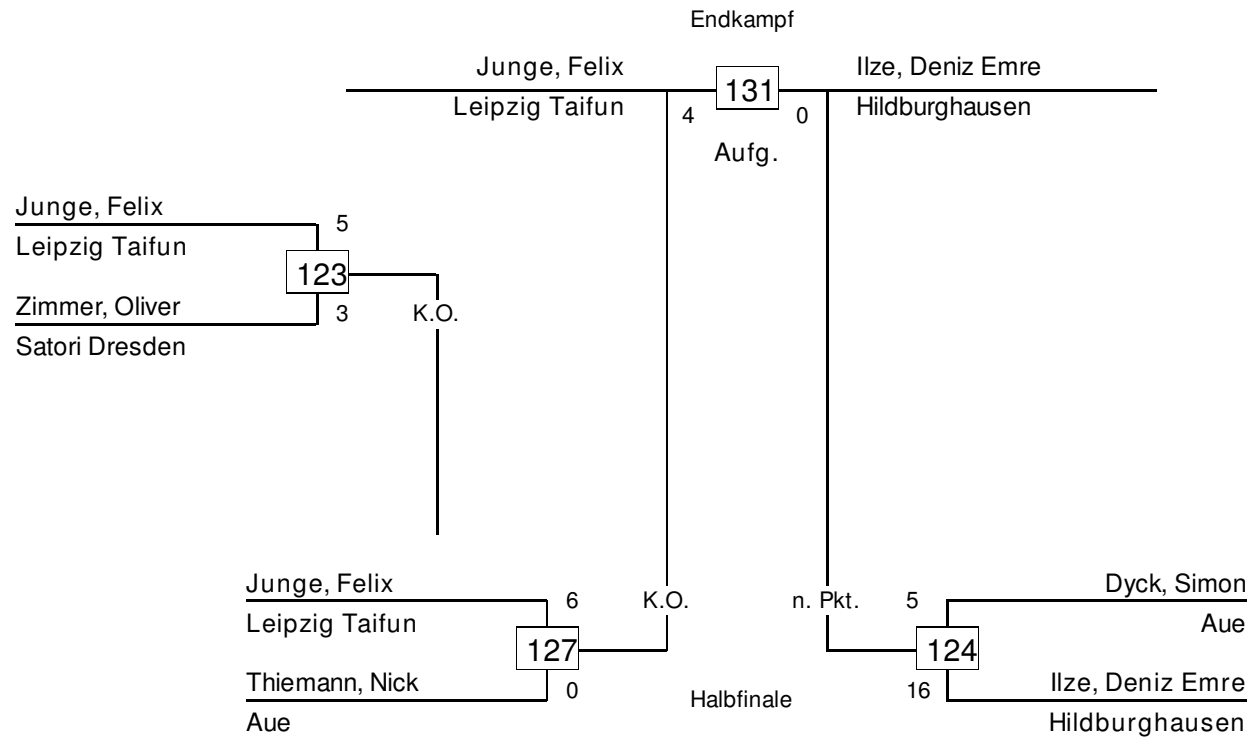

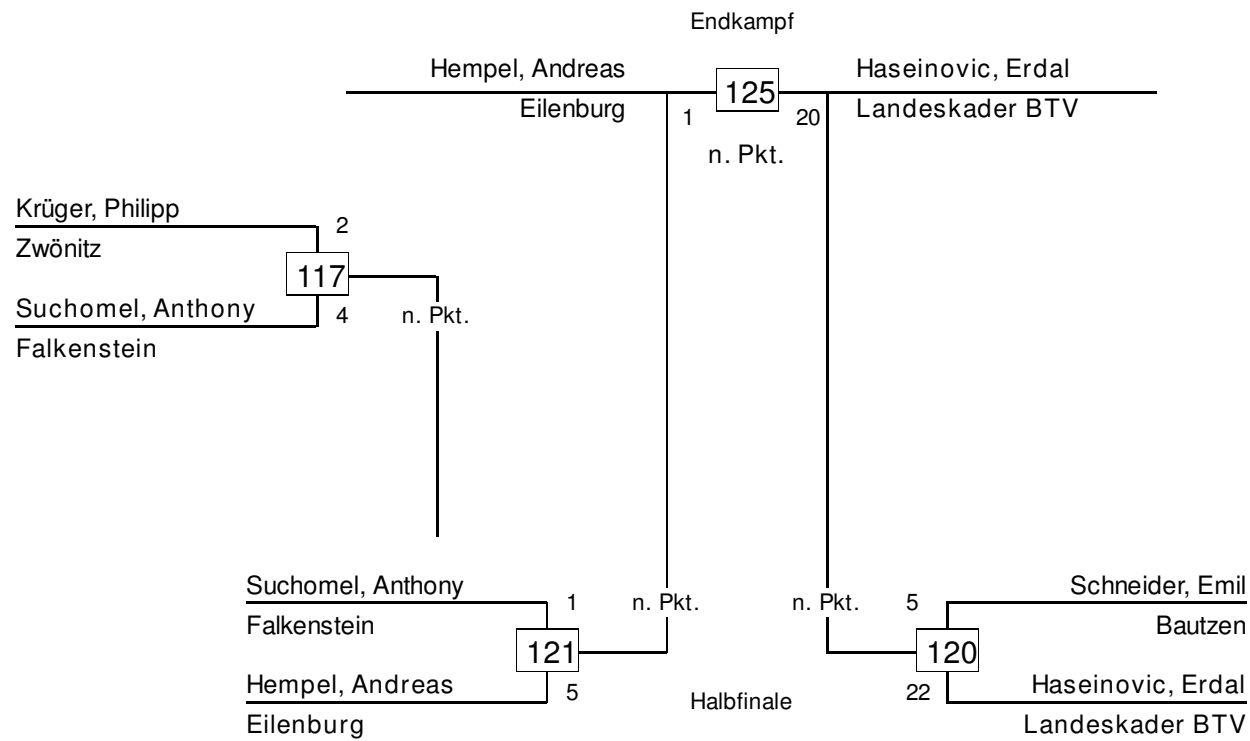



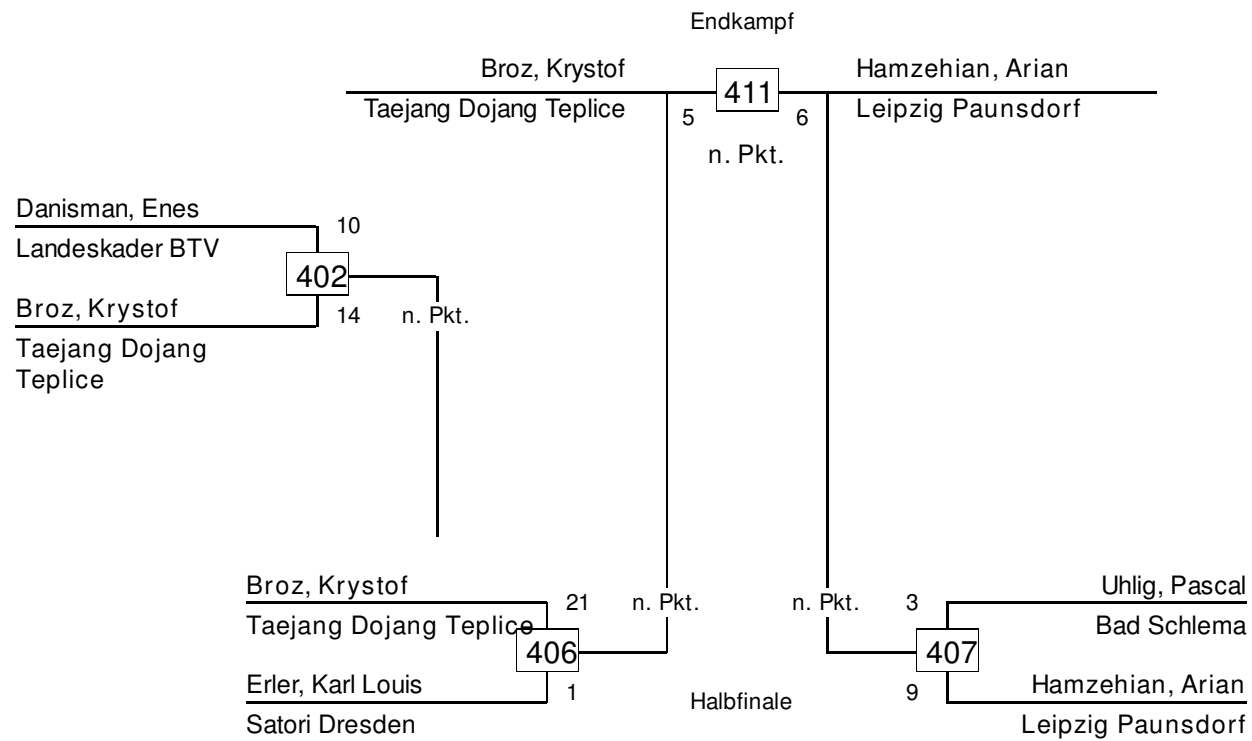

		Endkampf			
Erol, Kaan				Süß, Georg	
Landeskader BTV	4	426	2	Zwönitz	
		n. Pkt.			

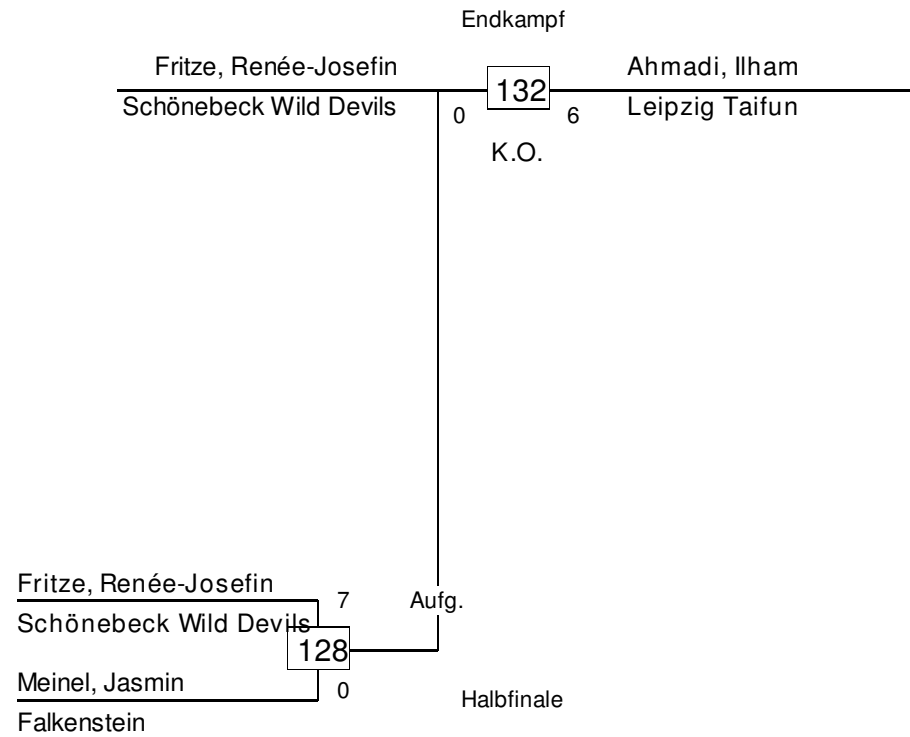

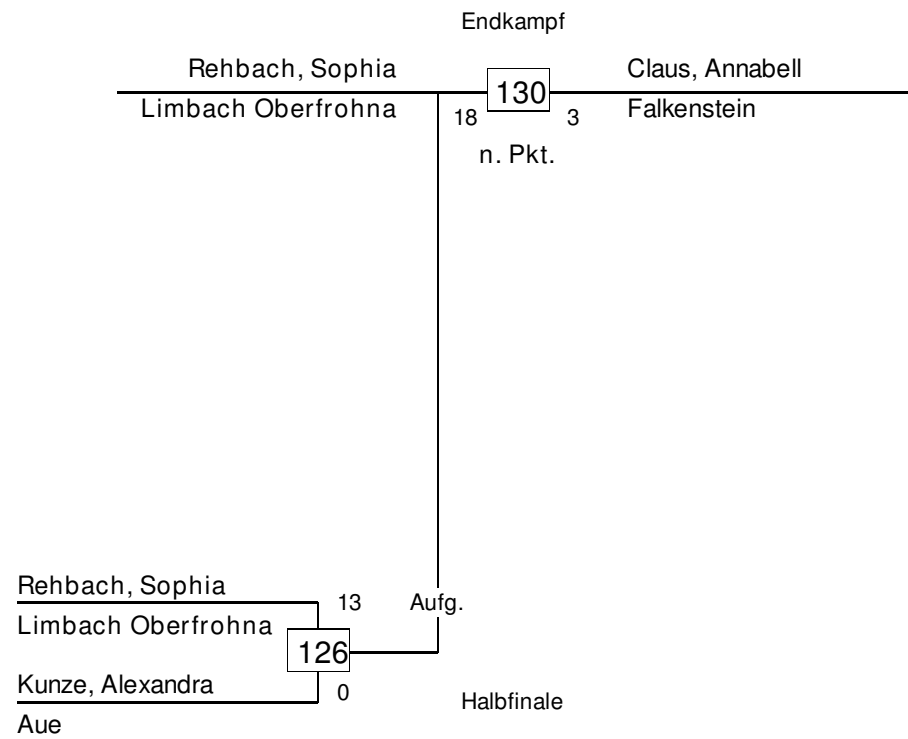

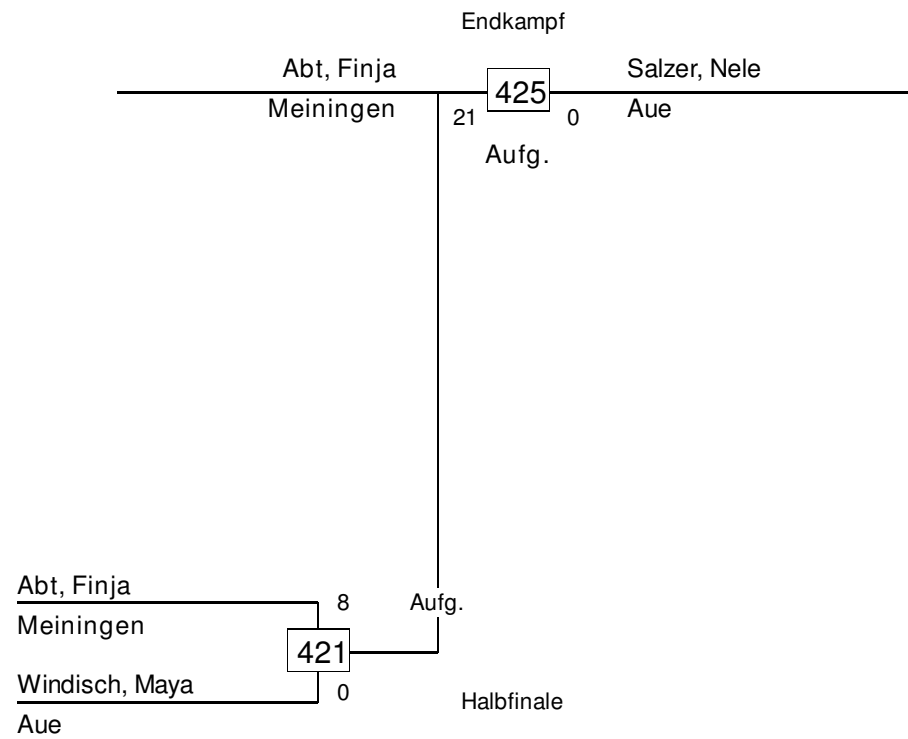

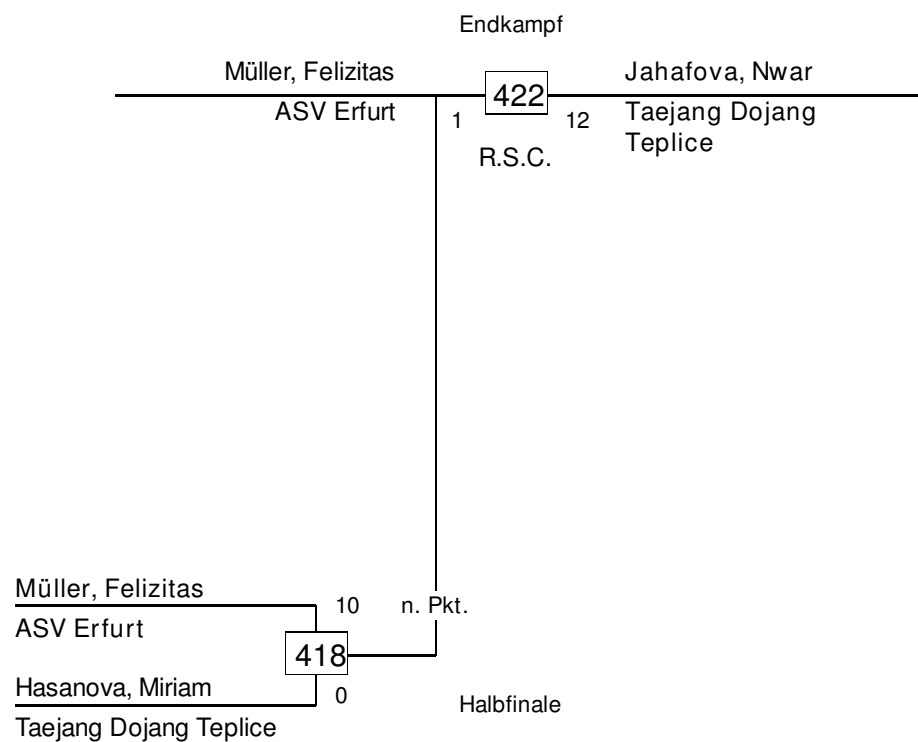

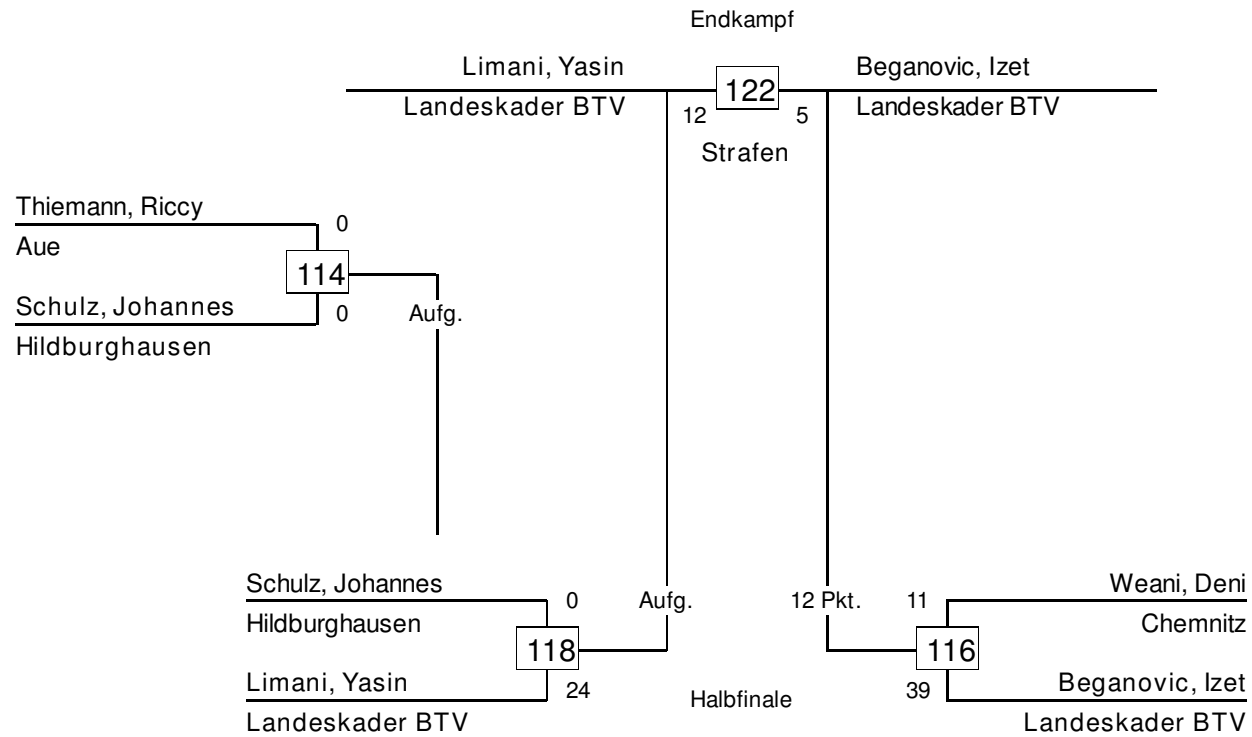

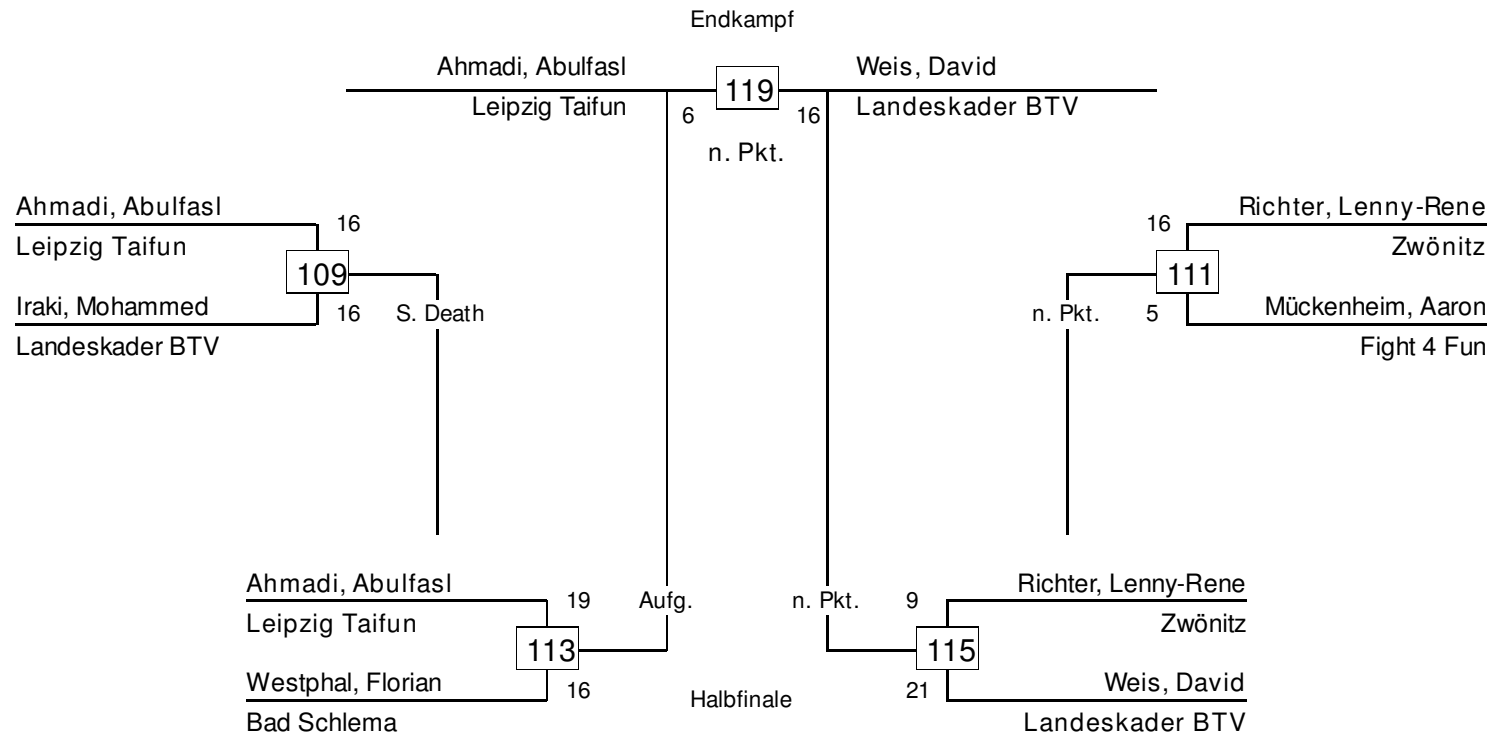



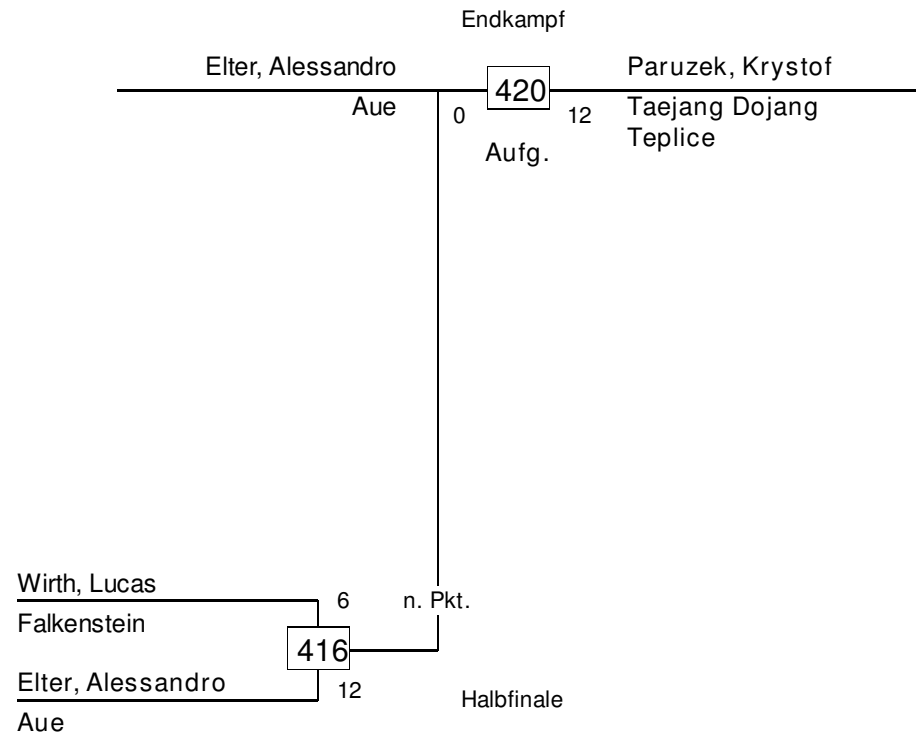

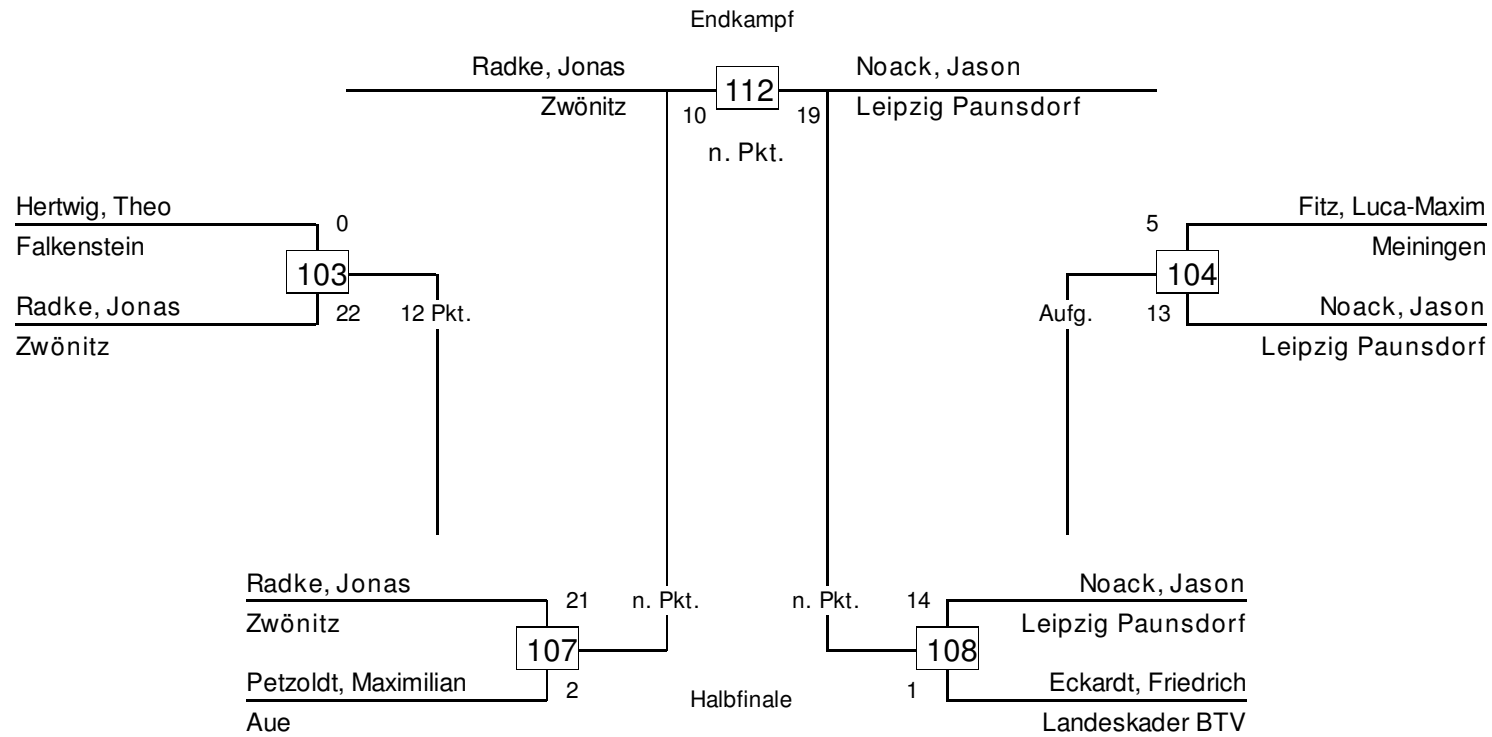

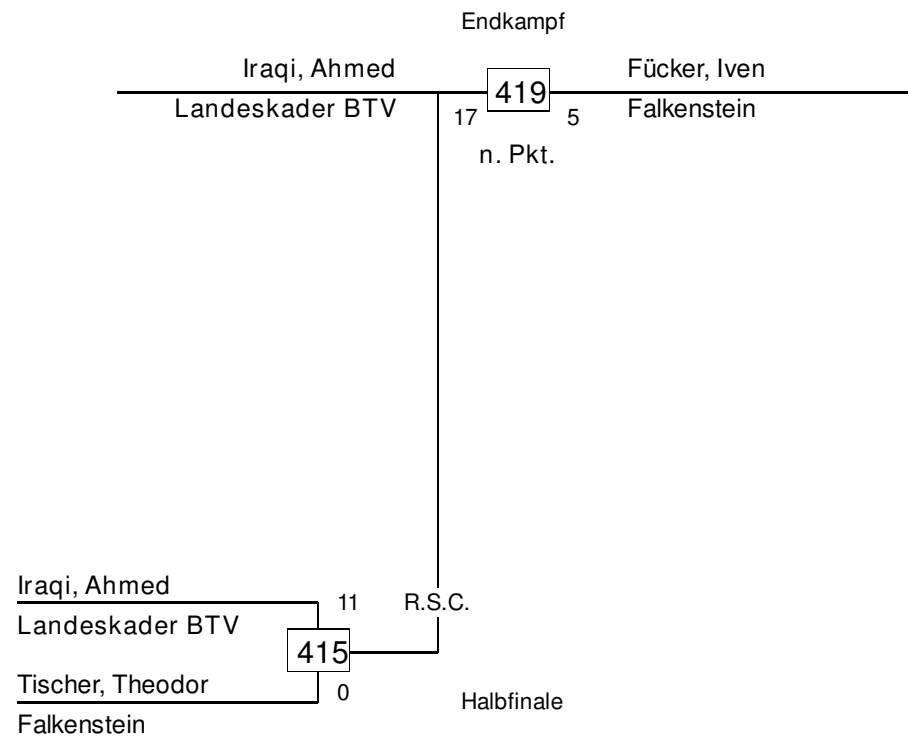

Endkampf

Beganovic, Sejfudin

Dähmow, Julien

Landeskader BTV

Eilenburg

25

429

6

12 Pkt.

		Endkampf			
Schickling, Phil				Friedrich, Ian	
Aue	5	129	26	Hohenstein-Ernstthal	
		12 Pkt.			

Endkampf

Erol, Havin Zeliha

Landeskader BTV

1

133

11

Limani, Elmedina

Landeskader BTV

Aufg.

